







Fixture Name: Madera 1821-1W BI

This fixture assembled PO: _____ Date: _____

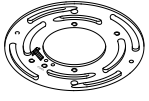
Notice: Please review the parts listing and check for all parts before assembling the fixture. If any parts are missing or damaged, please note on this sheet and contact the place of purchase to arrange for replacement parts.

PARTS LIST

Company Name: _____ Co. Account #: _____
below to be filled out by retailer

Mounting Strap 1ea 4" 	Junction Box Screw 2ea 8/32"x1" 	Mounting Screw 2ea 8/32"x32mm 
Wire Connector 3ea P4 Orange 	Hex Nut 2ea 8/32"x3.5mm 	Deco Nut (round nut) 2ea 12mm 
Green Ground Screw 1ea 8/32"x10mm 		

Part Needed _____	Quantity _____
Part Needed _____	Quantity _____
Reason why _____ Comments _____	(missing, scratched, broken glass, bent, bad finish)

FIXTURE ASSEMBLY INSTRUCTIONS

Read and review installation instruction sheet before assembling the fixture.

1. Install the light bulb in accordance with the fixture's specifications.

(DO NOT EXCEED THE MAXIMUM WATTAGE RATING!)

1821-1W BI

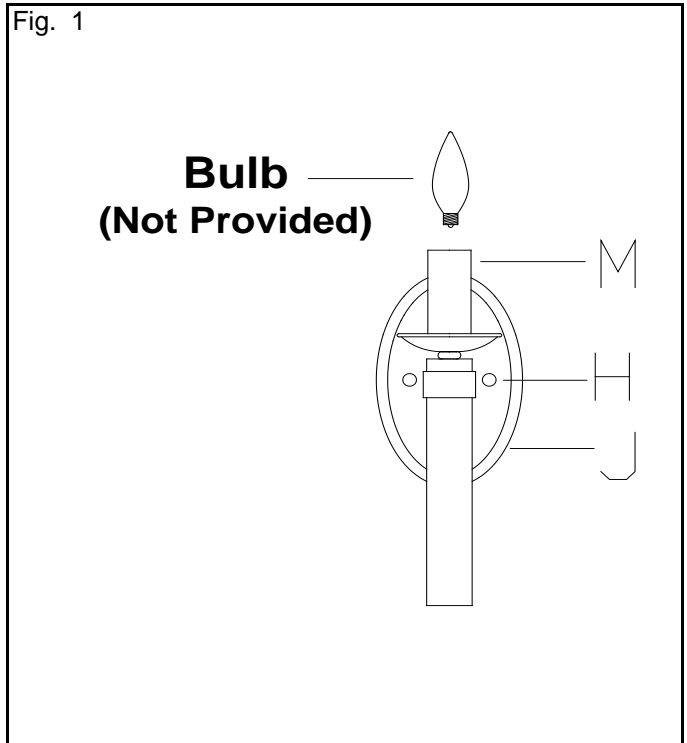

WARNING ! SHUT OFF POWER AT FUSE OR CIRCUIT BREAKER.

HANGING THE FIXTURE (Fig. 1)

1. Carefully remove the new fixture from the carton and the yellow bag that holds all your parts. Check that all parts are included as shown in the illustration and parts list.
2. Shut off power at the circuit breaker and remove the old fixture from wall, including the old mounting strap.
3. The Mounting Strap (A) contains several pairs of threaded holes, find the pair of holes that match the holes spacing in your fixture Back Plate (J) and thread the two Mounting Screws (B) into the Mounting Strap (A). Secure in place with the Hex nuts (C).
4. Place the Mounting Strap (A) over the Junction Box (E) so the Mounting Screws (B) are vertical or horizontal, as required by fixture type.
5. Attach the Mounting Strap (A) to the Junction Box (E) by using the two mounting screws (D). Tighten the screws securely.

CONNECTING THE WIRES (Fig. 2)

5. Attach the power supply wires to the fixture lead wires by connecting BLACK to BLACK (or SMOOTH) and WHITE to WHITE (or RIBBED).
 6. Attach the GROUND wire (GREEN or COPPER) from the Junction Box and the fixture Ground wire to the green Ground Screw on the Mounting Bracket (A) or connect both wires together using the correct size of wire connectors.
- NOTE:** Twist the wires together in the same direction you twist the wire connector onto the wires.
7. Tuck these wire connections neatly into the Junction Box.

FINISHING THE INSTALLATION (Fig.3)

9. Place the fixture Back Plate (J), over the Mounting screws (B), so they protrude through the holes in the Back Plate (J).
10. Thread the Deco Nuts (H) onto the Mounting Screws (B) and continue turning until the Back Plate (J) is snug against the wall.

YOUR INSTALLATION IS NOW COMPLETE.
RETURN POWER TO THE JUNCTION BOX AND TEST THE FIXTURE.

Fig. 1

JUNCTION BOX

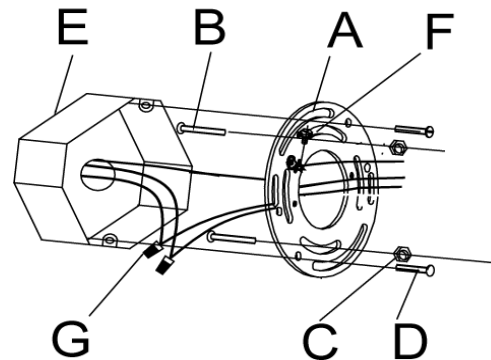

Fig. 2

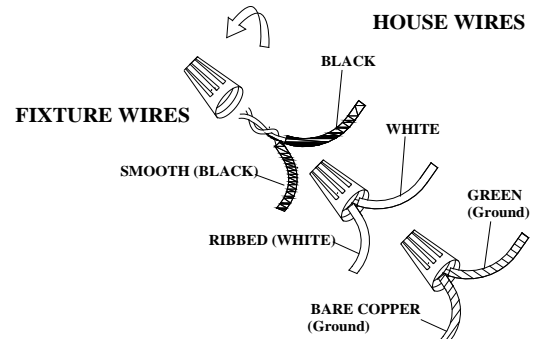

Fig. 3

